

● Receptacles Accessories Plug

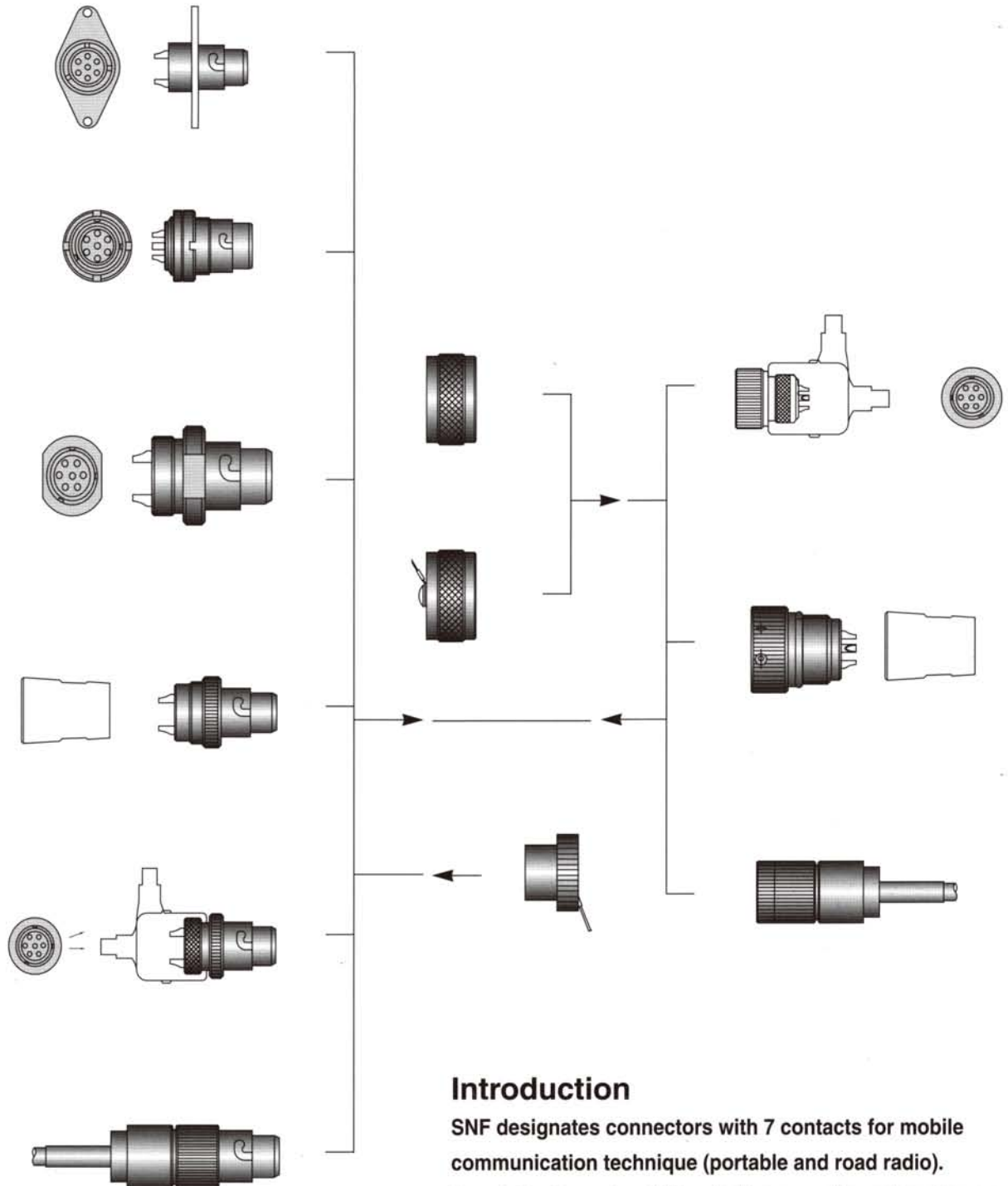

Introduction

SNF designates connectors with 7 contacts for mobile communication technique (portable and road radio). Special features in addition to the rugged construction are the scoop-proof press-on contacts and optimum shielding. Furthermore the connectors are sealed even when not mated. SNF-connectors are small, light and extremely reliable. They are manufactured according to VG 95351.

● Ordering Information

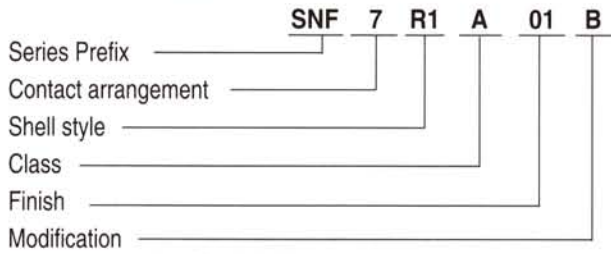

Series Prefix	SNF	- SUNGJIN designation
Contact arrangement	7	- 7 contacts
Shell style	R0	- Cable connecting receptacle
	R1	- Wall mounting receptacle
	R2	- Jam nut receptacle (hex nut)
	R3	- Jam nut receptacle (castellated nut)
	R5	- Jam nut receptacle featuring PG9 thread for adaption of standard (DIN part) gland nut
Class	A	- without accessories
	B	- with heatshrink boot adapter
	C	- with M14 x 1 thread
	D	- With strain relief and grounding continuity
Finish	01	- black chromate without designation
Modification		- standard with solder pot contacts
	B	- with dip solder contacts for PC board termination, ϕ 0.5mm, length 3mm
	K	- strain relief for cable ϕ 5-7mm

Plug

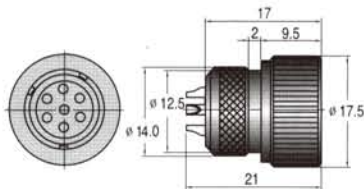

Receptacle

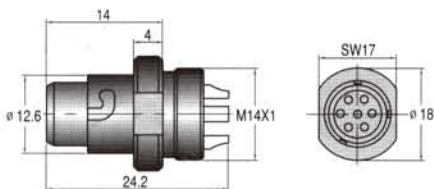

Technical Data

Electrical Data

Operating voltage	Max. 42 V, Min. 30 mV
Current rating	Max. 500 mA, Min. 30 A
Contact resistance	Max. 20m Ω
Max. operating temperature	-55° /85°C
acc. to	DIN IEC 68, part 1
Test voltage	500V
Insulation resistance	Min. 5° · 10 M Ω
Contact size resp.	0.5mm ² /AWG 20
dip solder pin	0.53mm
Environmental performance	test time acc. VG
(in mated and unmated condition)	4 m water/2 hours

Materials and Finishes

Shells	Stainless Steel, finish black chromate
Insulator	polyamide, glass filled
Sealings	Silicone rubber
Contacts	Copper alloy
Contact finish	Special gold plating

Receptacle

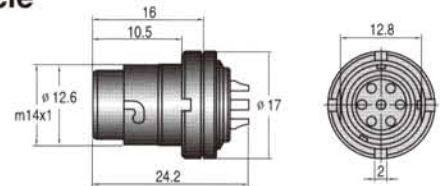

Plug

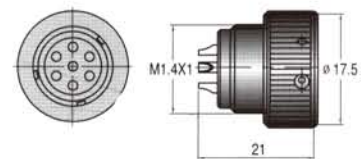

Receptacle

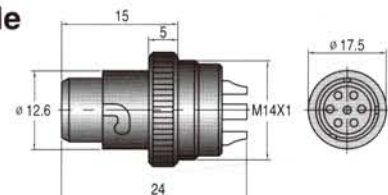

● Connectors Type SNF

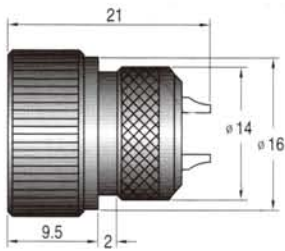

Straight VG 95351-A7
SNF 7R0B01

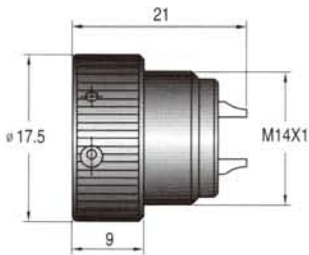

Straight VG 95351-A7
SNF 7R0C01

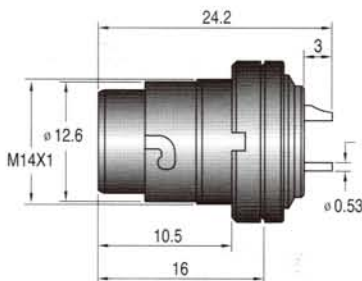

Jam Nut Receptacle
VG 95351-C7
SNF 7R 3A01/SNF 7R2A01

● U-183/U

RECEPTACLE

Spring loaded contacts, solder terminals, mates with U-229/U, GC 217 & GC 217A. Other pin styles available.

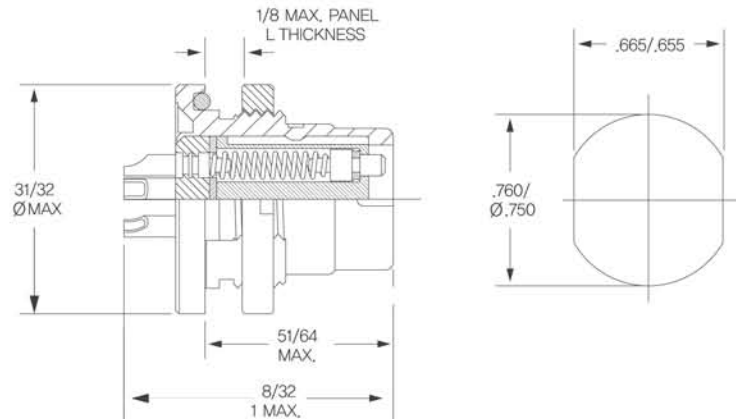

● U-228/U

PLUG

Spring loaded contacts, barrel pin terminals,* mates with U-229/U, GC 217 & GC 217A.

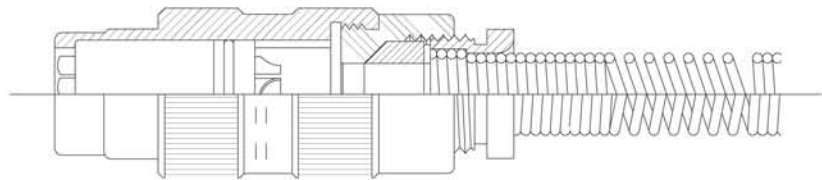

● U-229/U

PLUG

Rigid contacts, barrel pin terminals,* mates with U-183/U, U-228/U & GC183S.

